

Ma

KEY STAGE
3

TIER
5–7

2001

Mathematics test

Paper 1

Calculator not allowed

Please read this page, but do not open the booklet until your teacher tells you to start. Write your name and the name of your school in the spaces below. If you have been given a pupil number, write that also.

First name _____

Last name _____

School _____

Pupil number

--	--	--	--	--	--

Remember

- The test is 1 hour long.
- You **must not** use a calculator for any question in this test.
- You will need: pen, pencil, rubber and a ruler.
- Some formulae you might need are on page 2.
- This test starts with easier questions.
- Try to answer all the questions.
- Write all your answers and working on the test paper – do not use any rough paper.
- Check your work carefully.
- Ask your teacher if you are not sure what to do.

For marker's
use only

Total marks

--

Instructions

Answers



This means write down your answer or show your working and write down your answer.

Calculators



You **must not** use a calculator to answer any question in this test.

Formulae

You might need to use these formulae.

Trapezium

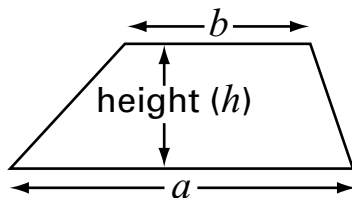

$$\text{Area} = \frac{(a + b)}{2} \times h$$

Prism

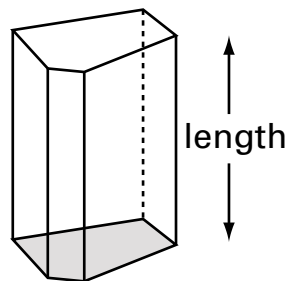

$$\text{Volume} = \text{area of cross-section} \times \text{length}$$

1. The diagram shows a box.

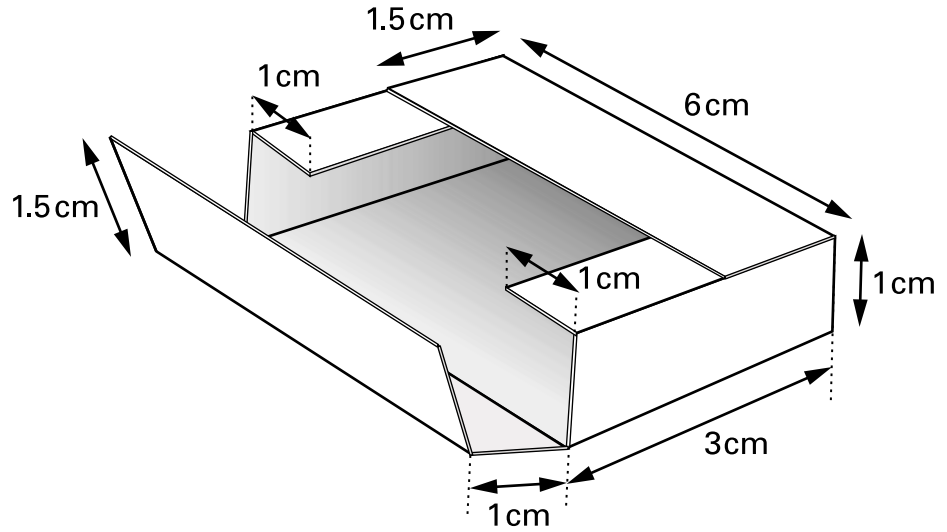

Complete the **net** for the box.

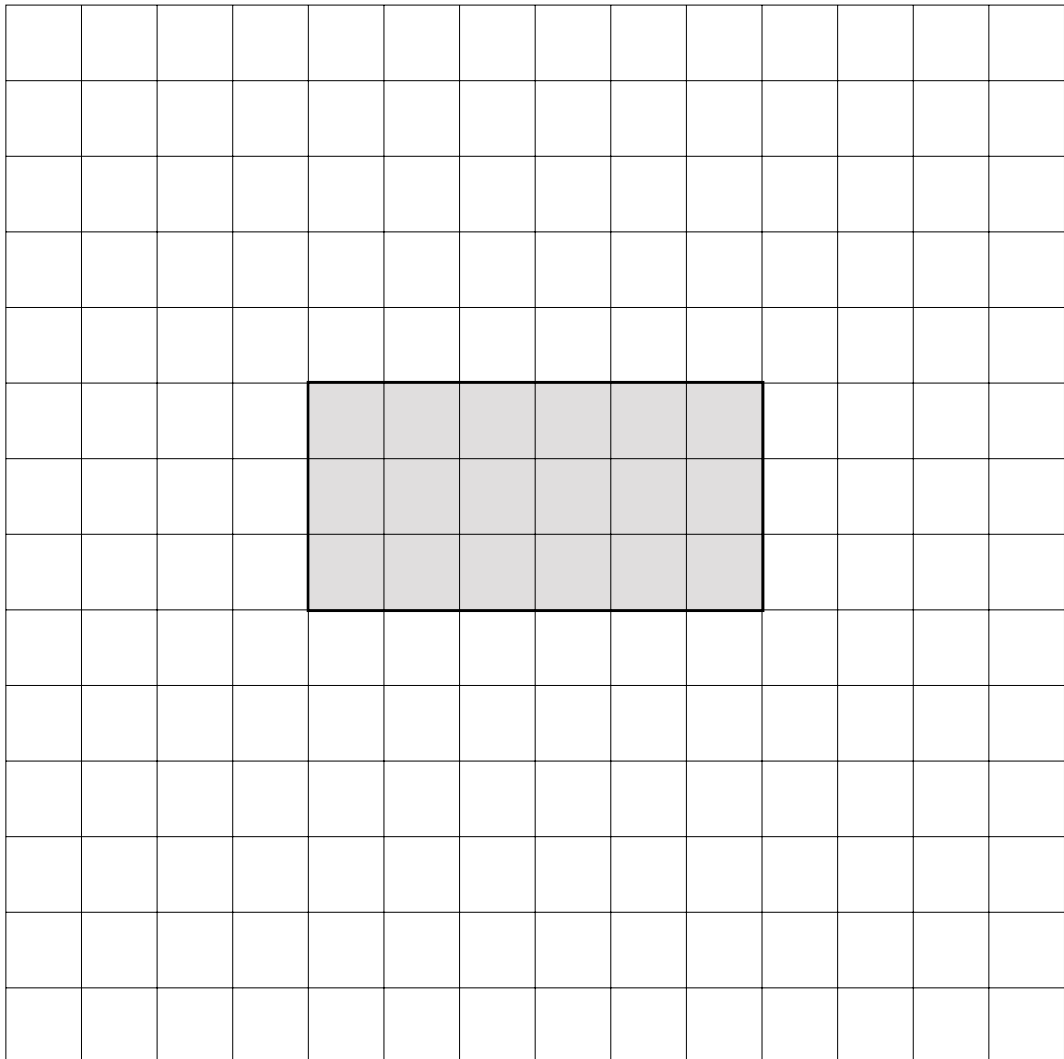

.....

 3 marks



2. Mark and Kate each buy a family pack of crisps.
Each family pack contains **ten bags** of crisps.

The table shows how many bags of each flavour are in each family pack.

flavour	number of bags
plain	5
vinegar	2
chicken	2
cheese	1

- (a) Mark is going to take a bag of crisps at random from his family pack.
Complete these sentences.



The probability that the flavour will be is $\frac{1}{2}$
1 mark

The probability that the flavour will be **cheese** is
1 mark

- (b) Kate ate **two bags** of **plain** crisps from her family pack of 10 bags.
Now she is going to take a bag at random from the bags that are left.
What is the probability that the flavour will be **cheese**?



.....
1 mark

(c) A shop sells **12 bags** of crisps in a large pack.

I am going to take a bag at random from the large pack.

The table below shows the probability of getting each flavour.

Use the probabilities to work out **how many bags** of each flavour are in this large pack.



flavour	probability	number of bags
plain	$\frac{7}{12}$	
vinegar	$\frac{1}{4}$	
chicken	$\frac{1}{6}$	
cheese	0	

.....
.....
2 marks



3. The diagrams show the number of hours of sunshine in two different months.

Number of hours of sunshine in month A

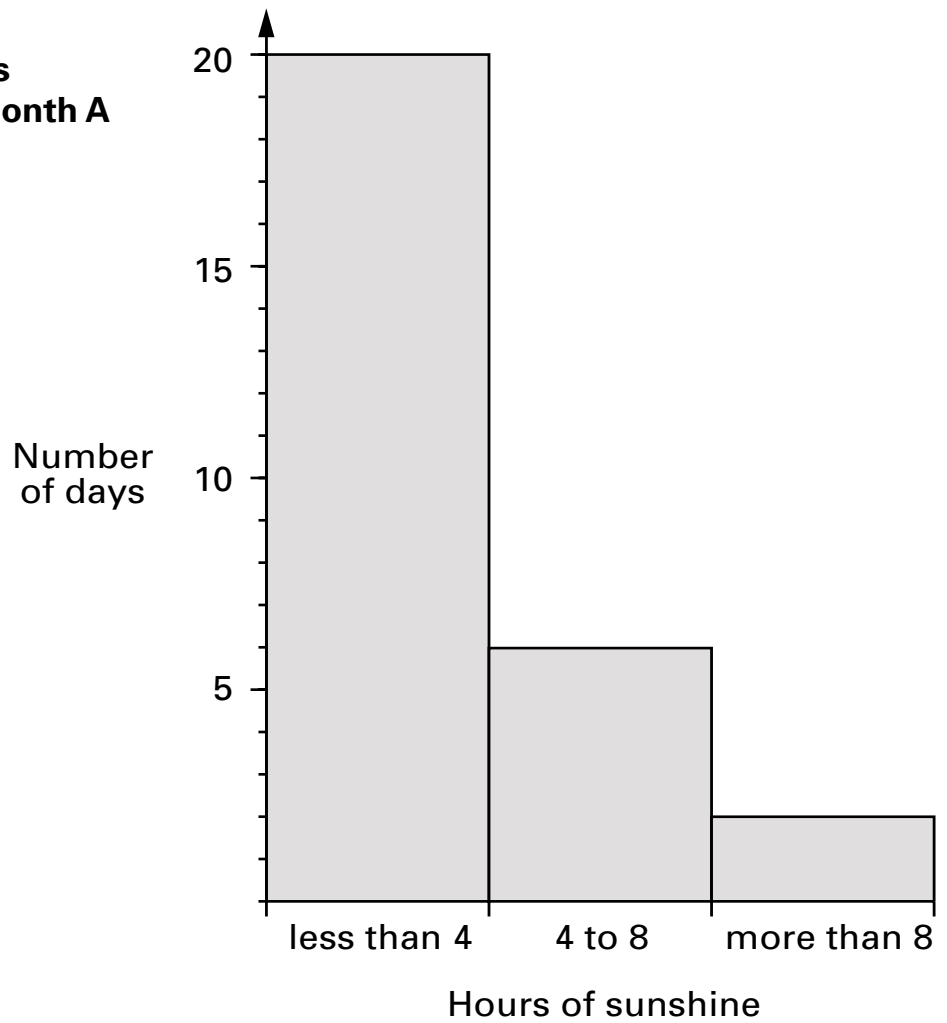

Number of hours of sunshine in month B

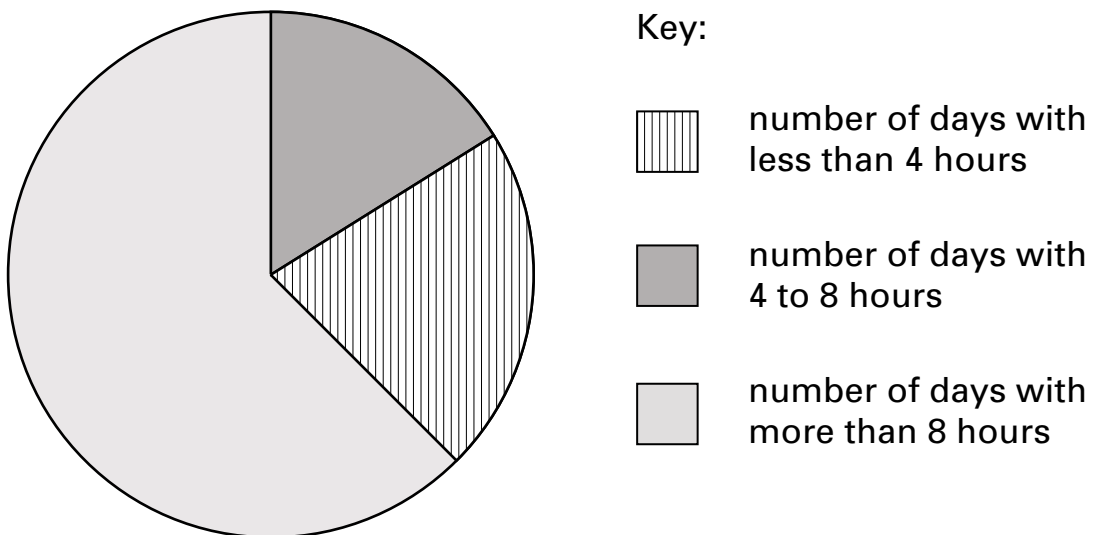

(a) How many days are there in **month A**?

Tick (✓) the correct box.



28

29

30

31

not possible
to tell

1 mark

(b) How many days are there in **month B**?

Tick (✓) the correct box.



28

29

30

31

not possible
to tell

1 mark

(c) Which month had more hours of sunshine?

Tick (✓) the correct box.



month A

month B

Explain how you know.



1 mark



4. (a) Look at these fractions.

$$\frac{1}{2}$$

$$\frac{1}{3}$$

$$\frac{5}{6}$$

Mark each fraction on the number line.

The first one is done for you.

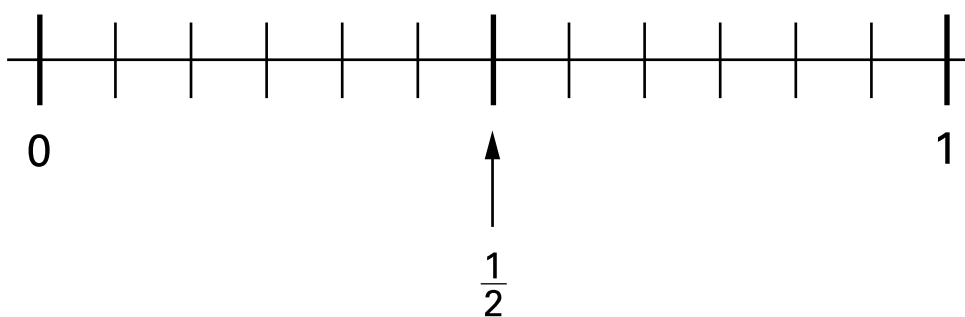

.....
1 mark

(b) Fill in the missing numbers in the boxes.



$$\frac{2}{12} = \frac{\square}{6}$$

$$\frac{1}{2} = \frac{12}{\square}$$

$$\frac{1}{\square} = \frac{6}{24}$$

.....

.....
2 marks

5. (a) What **fraction** of this shape is shaded?
Write your fraction as simply as possible.



.....

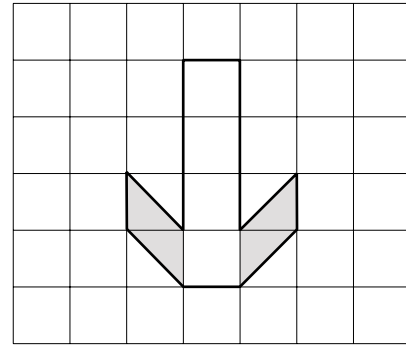

.....
1 mark

- (b) What **percentage** of this shape is shaded?



..... %

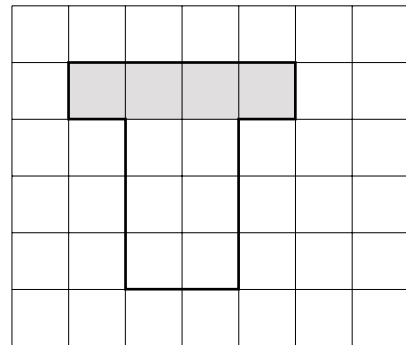

.....
1 mark

- (c) Which shape has the **greater percentage** shaded?

Tick (✓) the correct box.



Shape A

Shape B

Both the same

Explain how you know.

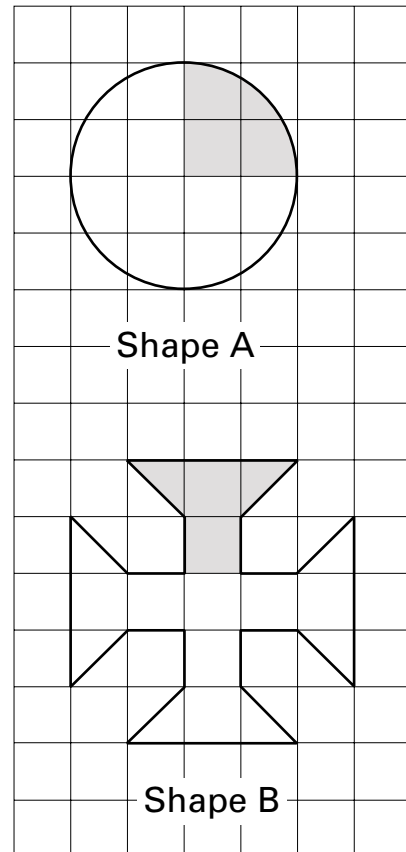

Shape A

Shape B

.....
1 mark



6. (a) A football club is planning a trip.

The club hires **234** coaches. Each coach holds **52** passengers.

How many passengers is that altogether?

Show your working.



.....
..... passengers
.....
2 marks

(b) The club wants to put one first aid kit into each of the 234 coaches.

These first aid kits are sold in **boxes of 18**

How many boxes does the club need?



..... boxes
.....
1 mark

7. There are **60 pupils** in a school.
6 of these pupils wear glasses.

(a) The pie chart is not drawn accurately.

What should the angles be?
 Show your working.

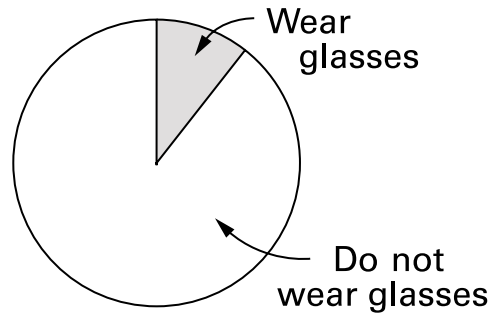

.....
 ° and °

 2 marks

(b) Exactly **half** of the 60 pupils in the school are boys.

From this information, what **percentage of boys** in this school **wear glasses**?
 Tick (✓) the correct box below.



5% <input type="checkbox"/>	6% <input type="checkbox"/>	10% <input type="checkbox"/>
20% <input type="checkbox"/>	50% <input type="checkbox"/>	not possible to tell <input type="checkbox"/>

.....
 1 mark



8. Ali, Barry and Cindy each have a bag of counters.
They do not know how many counters are in each bag.
They know that

Barry has **two more** counters than Ali.

Cindy has **four times as many** counters as Ali.

- (a) Ali calls the number of counters in her bag a

Write **expressions using a** to show the number of counters in Barry's bag and in Cindy's bag.

Ali's bag

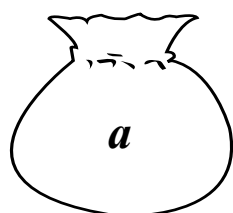

Barry's bag

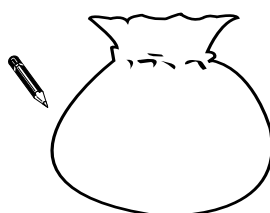

Cindy's bag

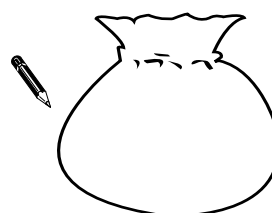

.....
1 mark

- (b) Barry calls the number of counters in his bag b

Write **expressions using b** to show the number of counters in Ali's bag and in Cindy's bag.

Ali's bag



Barry's bag

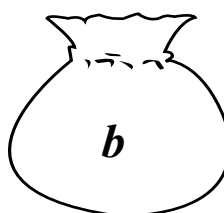

Cindy's bag

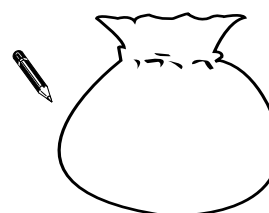

.....
.....
2 marks

(c) Cindy calls the number of counters in her bag c

Ali's bag

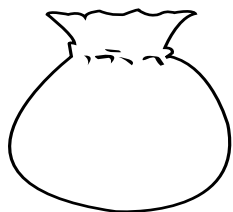

Barry's bag

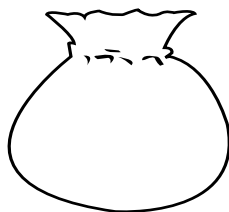

Cindy's bag

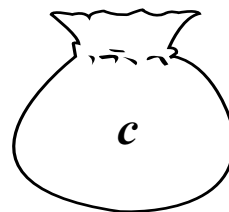

Which of the expressions below shows the number of counters in **Barry's** bag?

Circle the correct one.



$$4c + 2$$

$$4c - 2$$

$$\frac{c}{4} + 2$$

$$\frac{c}{4} - 2$$

$$\frac{c + 2}{4}$$

$$\frac{c - 2}{4}$$

.....
1 mark



Now look at the triangle drawn on the straight line PQ

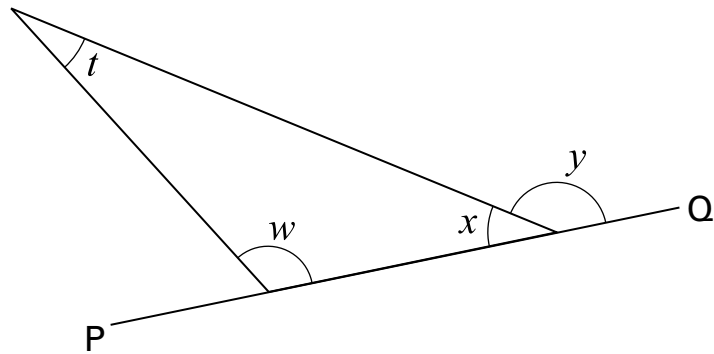

(c) Write x in terms of y



.....
1 mark

(d) Now write x in terms of t and w



.....
1 mark

(e) Use your answers to parts (c) and (d) to show that $y = t + w$



.....
1 mark



10. Here are three number cards.
The numbers are hidden.

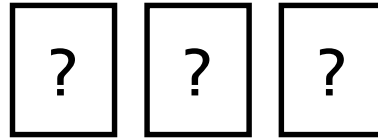

The **mode** of the three numbers is **5**
The **mean** of the three numbers is **8**

What are the three numbers?
Show your working.



.....
..... / /
.....
2 marks

11. On a farm **80** sheep gave birth.
30% of the sheep gave birth to two lambs.
The rest of the sheep gave birth to just one lamb.
In total, how many lambs were born?
Show your working.



.....
..... lambs
.....
2 marks

12. Two parts of this square design are shaded black.
Two parts are shaded grey.

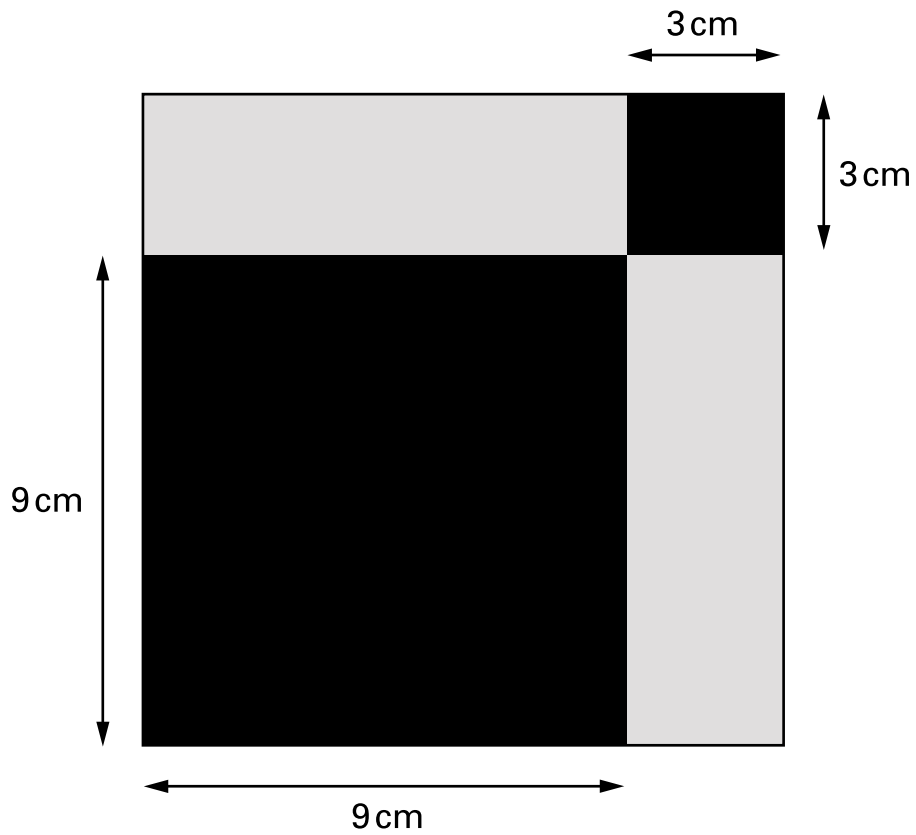

Show that the ratio of black to grey is **5 : 3**



.....

.....
2 marks



13. (a) Solve this equation.

$$7 + 5k = 8k + 1$$



$$k = \dots\dots\dots$$

.....
1 mark

(b) Solve this equation. Show your working.

$$10y + 23 = 4y + 26$$



$$y = \dots\dots\dots$$

.....
.....
2 marks

14. (a) Look at these numbers.

$$1^6$$

$$2^5$$

$$3^4$$

$$4^3$$

$$5^2$$

$$6^1$$

Which is the **largest**?



.....

.....
1 mark

Which is equal to 9^2 ?



.....

.....
1 mark

(b) Which **two** of the numbers below are **not** square numbers?

$$2^4$$

$$2^5$$

$$2^6$$

$$2^7$$

$$2^8$$



..... and

.....
1 mark



15. (a) m is an **odd** number.

Which of the numbers below must be even, and which must be odd?

Write 'odd' or 'even' under each one.

	$2m$	m^2	$3m - 1$	$(m - 1)(m + 1)$

.....

.....
2 marks

(b) m is an **odd** number.

Is the number $\frac{m+1}{2}$ odd, or even, or is it not possible to tell?

Tick (✓) the correct box.

	odd		even		not possible to tell	

Explain your answer.



.....
1 mark

16. (a) Alan has a guessing game on his computer.
He estimates that the probability of **winning** each game is **0.35**

Alan decides to play **20** of these games.

How many of these games should he expect to **win**?



.....

.....
1 mark

- (b) Sue played the same computer game.

She won **12** of the games she played, and so
she estimated the probability of winning each game to be **0.4**

How many games did Sue play?

Show your working.



.....

.....
2 marks

- (c) The manufacturers of another guessing game claim that the probability of winning each game is **0.65**

Karen plays this game **200** times and **wins 124** times.

She says: 'The manufacturers must be wrong'.

Do you agree with her? Tick (✓) Yes or No.



Yes No

Explain your answer.



.....
1 mark



17. Here are six different equations, labelled A to F

A	$y = 3x - 4$	B	$y = 4$	C	$x = -5$
D	$x + y = 10$	E	$y = 2x + 1$	F	$y = x^2$

Think about the graphs of these equations.

(a) Which graph goes through the point **(0, 0)**?



.....

.....
1 mark

(b) Which graph is **parallel** to the y -axis?



.....

.....
1 mark

(c) Which graph is **not a straight line**?



.....

.....
1 mark

(d) Which **two** graphs pass through the point **(3, 7)**?



..... and

.....
2 marks

(e) The diagram shows the graph of the equation $y = 4 - x^2$

What are the coordinates of the points where the graph of this equation meets the graph of equation E ?

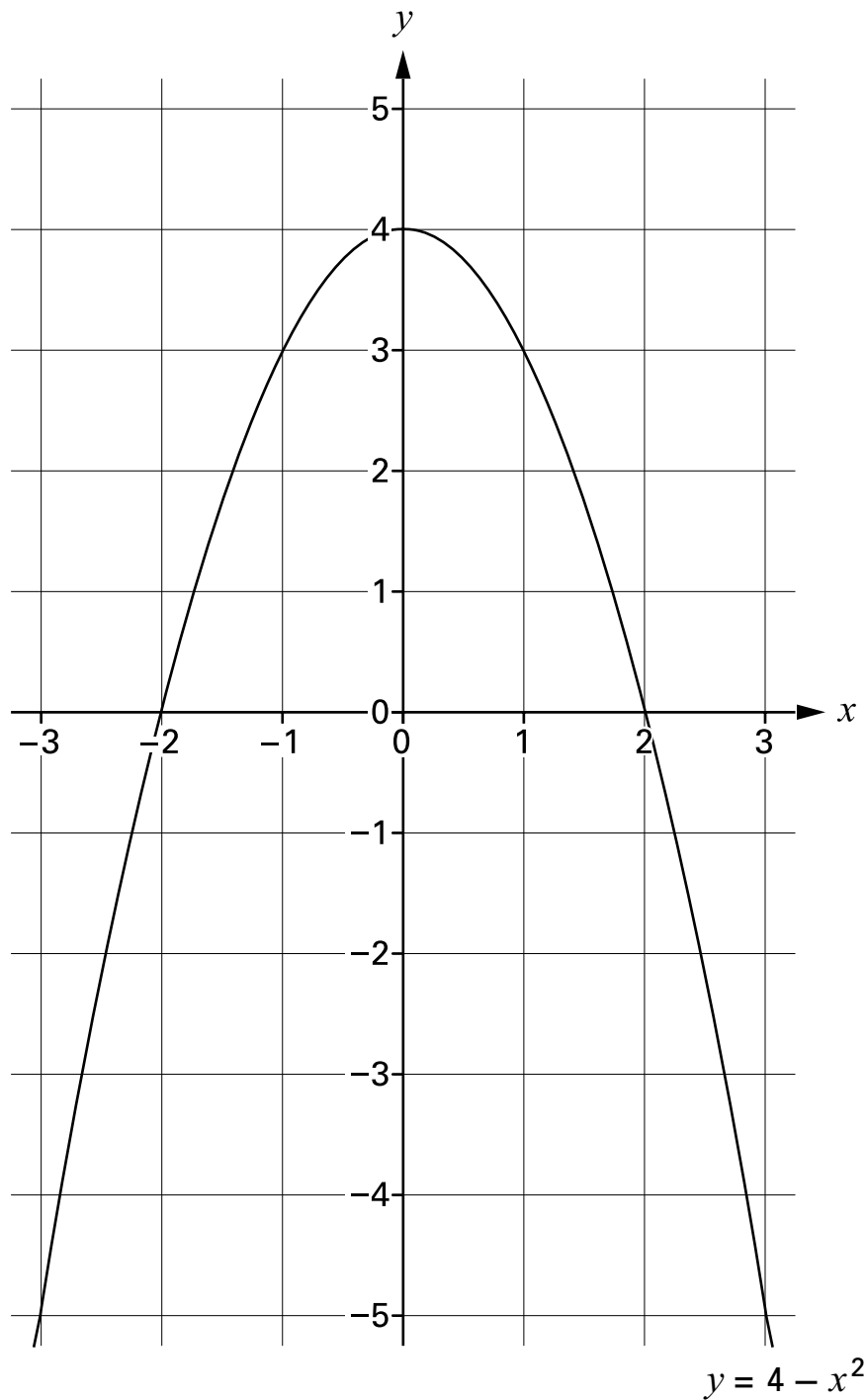

(,) and (,)

.....

.....

3 marks



